

**M12 male 0° / M12 female 0° Cube67 F&B Pro**

TPE-S 0.5+0.25 shielded bu UL robot+drag ch. 0,3m

Plug Connectors for Food &amp; Beverage

The resistance to aggressive media should be individually tested for your application. Further details on request.

Further cable lengths on request.

Male straight – female straight

M12 F&amp;B Pro

6-pole

Stainless steel 1.4404 (V4A)

without cable sleeves

IP69K

Cube67

Plastic housings with good resistance against chemicals and oils.

[Link to Product](#)**Illustration**

Product may differ from Image

**Approvals**

**More Info**

Cube67

**Form**

Form 46041

**General data**

Standards	DIN EN 61076-2-101 (M12), FDA conform
Mounting method	inserted, tightened
Material (contact)	Copper alloy
Material (contact surface)	Au
Material (gasket)	EPDM
Material (contact carrier)	PP, ice blue
Pollution Degree	3
Temperature range	-40...+105 °C, depending on cable quality

**Cables**

Cable identification	523
Approval (cable)	UL (AWM-Style 22126/11558), CE conform
Cable weight [g/m]	82,5
Material (wire)	Cu wire, bare
Resistor (core)	max. 39 Ω/km (0.5 mm <sup>2</sup> ), max. 78 Ω/km (0.25 mm <sup>2</sup> ); (20 °C)

Single wire Ø (core)	0.15 mm (0.5 mm <sup>2</sup> ); 0.1 mm (0.25 mm <sup>2</sup> )
Construction (core)	28× 0.15 mm (0.5 mm <sup>2</sup> ); 32× 0.1 mm (0.25 mm <sup>2</sup> ); (multi-strand wire class 6)
Diameter (core)	4× 0.5 + 2× 0.25 mm <sup>2</sup>
AWG	similar to AWG 20 (0.5 mm <sup>2</sup> ); similar to AWG 24 (0.25 mm <sup>2</sup> )
Material (wire isolation)	PP
Wire-Ø incl. isolation	1.5 mm ±5% (0.5 mm <sup>2</sup> ); 1.4 mm ±5% (0.25 mm <sup>2</sup> )
Color/numbering of wires	(bl, wh, br, bk) + (gr, pk)
Shield	yes
	min. 80%
Material (jacket)	TPE-S
Outer-Ø (jacket)	7.9 mm ±5%
Color (jacket)	pastel blue
Nominal voltage	300 V AC
Test voltage	3000 V
Temperature range (fixed)	-40...+105 °C
Temperature range (mobile)	-25...+105 °C
Bend radius (fixed)	5× outer Ø
Bend radius (moving)	10× outer Ø
No. of bending cycles (C-track)	max. 4 Mio. (25 °C)
Traversing distance (C-track)	max. 10 m
Travel speed (C-track)	max. 3 m/s
Acceleration (C-track)	max. 10 m/s <sup>2</sup>
Torsion stress	±180°/m
No. of torsion cycles	max. 2 Mio. (25 °C)
Jacket Color	gray

#### Technical Data

Operating voltage	max. 30 V AC/DC
Rated surge voltage	0.8 kV
Operating current per contact	max. 4 A
No. of poles	6
Material group	IEC 60664-1, category I
Coding	A-coded
LED display	no
Locking of ports	Screw thread (M12×1 mm) recommended torque 0.6 Nm, self-securing
Compression gland	M12 (SW14)
Protection	IP65, IP68, IP69K inserted and tightened (EN 60529)
Material	PP
Locking material	Stainless steel 1.4404 (V4A)
suitable for corrugated tube (internal Ø)	without

#### Commercial data

country of origin	DE
customs tariff number	85444290
EAN	4048879756525
eClass	27061801
Packaging unit	1

#### Sketch

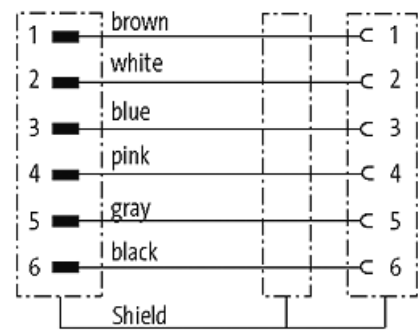

Male

Female

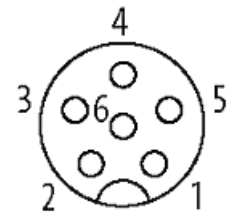
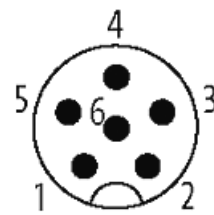

Product may differ from Image